

PREPARED FOR: **Sands**
LAS VEGAS SANDS CORP.

PAR20

LED PAR LAMP PRODUCT DATASHEET

REV: A
11/2010



PART NUMBER DESIGNATION

PART NUMBER: ICE R20-3000-NF
DESCRIPTION: PAR20, 3000K, NARROW FLOOD BEAM

BENEFITS & FEATURES

- RoHS Compliant Contains no mercury or lead
- Dimmable drive electronics enable dimming with most Triac (standard) wall dimmers.
- World leading LED technology inside enables world class performance for light output.
- CBCP exceeds ENERGY STAR® Integral LED lamp center beam intensity benchmarks.
- Thermal monitoring circuitry ensure that the lamp will automatically reduce power levels to protect itself. Can be used in recessed fixtures without overheating.
- Assembled in North America with solid supply chain management practices - ensures quality components throughout.

DIMENSIONS

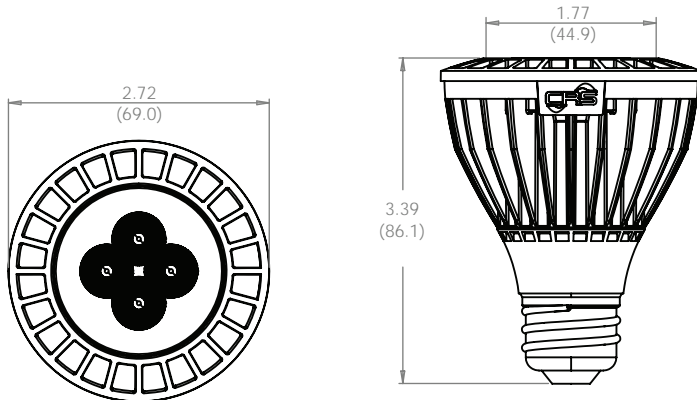

SPECIFICATIONS

INPUT POWER: 10W

VOLTAGE: 120 VAC (60HZ)

LUMINOUS FLUX: 500 LM

CCT: 3000K (WARM WHITE)

CRI: 85

OPTICAL BEAM: NARROW FLOOD

RATED LIFE: 50,000 HOURS

WARRANTY: 5 YEARS

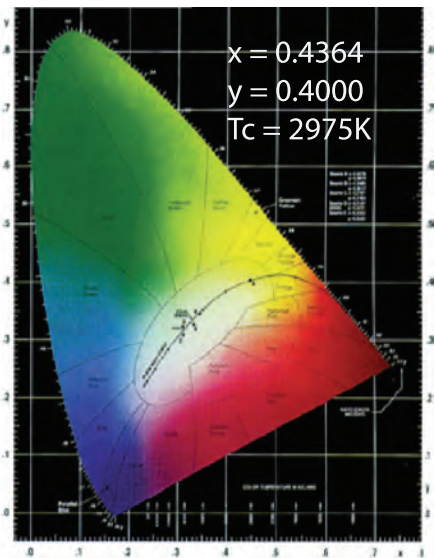

SUBJECT TO CHANGE WITHOUT NOTICE